

DANPAL® SISTEMA FACHADAS



DANPAL® SISTEMA FACHADAS



DANPAL® SOLUCIONES

FACADES



CLADDING



SKYLIGHTS

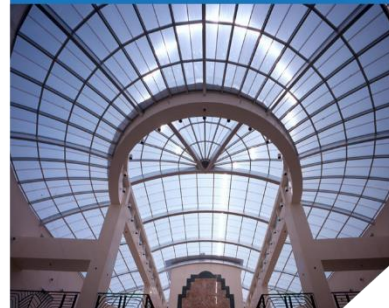

OUTDOOR



SHADING



INTERIOR



DANPAL® SOLUCIONES

FACADES



CLADDING

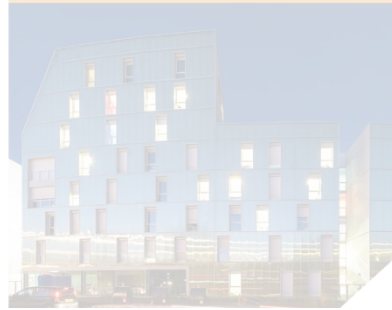

SKYLIGHTS



OUTDOOR



SHADING



INTERIOR



REFERENCIAS DE FACHADAS



REFERENCIAS DE FACHADAS



REFERENCIAS DE FACHADAS



REFERENCIAS DE FACHADAS

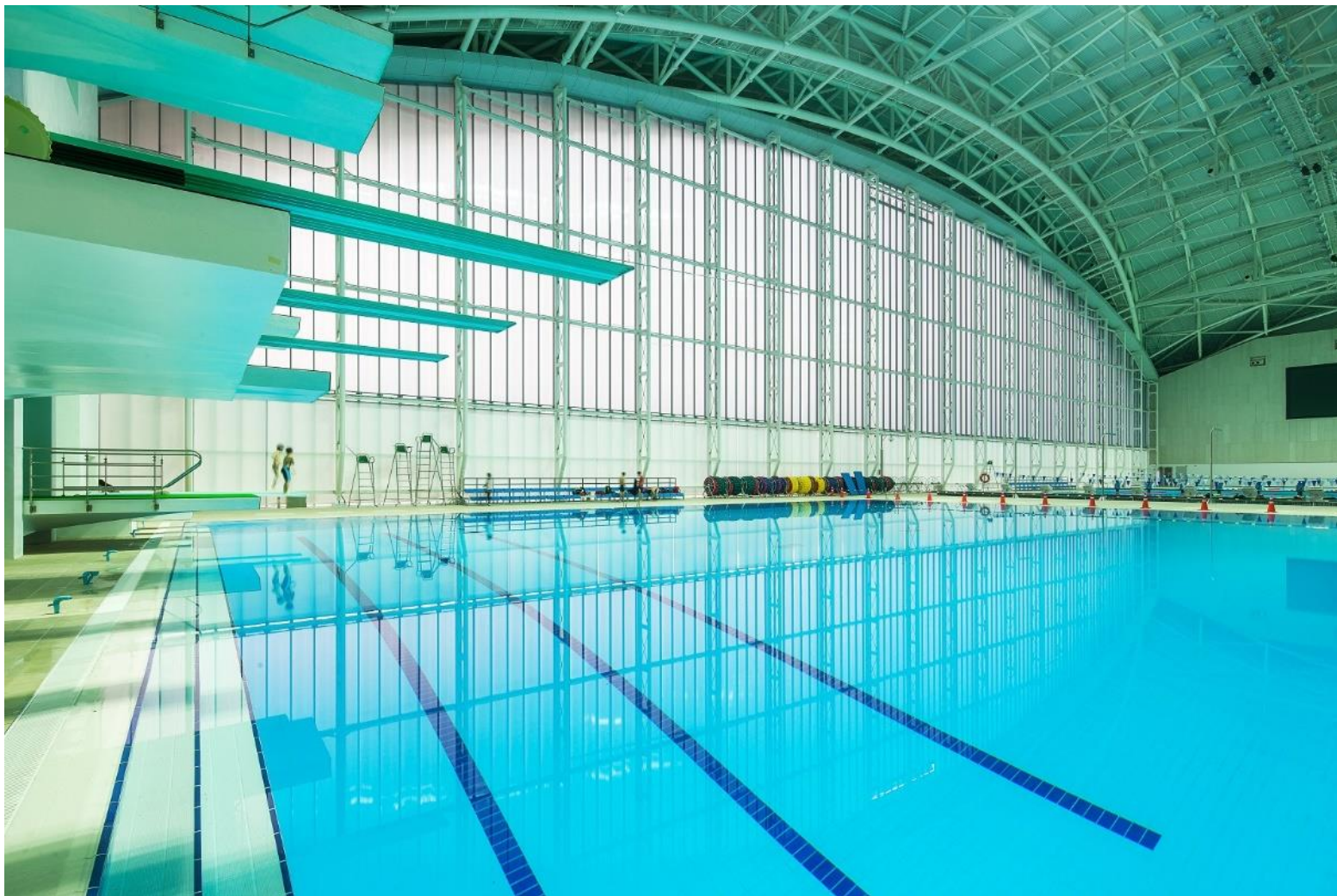

REFERENCIAS DE FACHADAS



REFERENCIAS DE FACHADAS



REFERENCIAS DE FACHADAS



REFERENCIAS DE FACHADAS



REFERENCIAS DE FACHADAS



DANPAL CONTROLITE SISTEMA FACHADAS

- Sistema único de fachada de policarbonato electrónico en el mercado.
- Controla la luz automáticamente

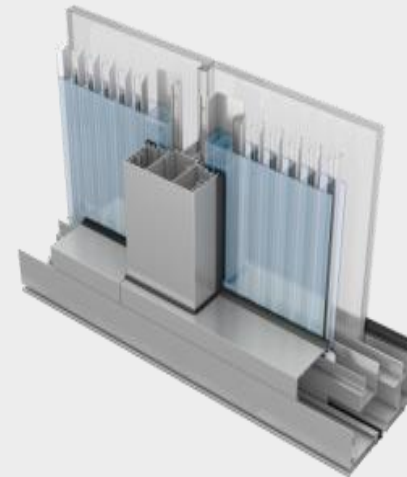
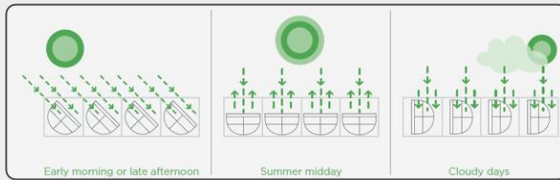
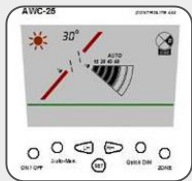

Especificaciones: Sistema de fachada de control de luz automático

DANPAL CONTROLITE SISTEMA FACHADAS

- Mayor comodidad a través de la “optimizada” luz del día”.
- Maximiza la luz del día en invierno y en días nublados.
- Refleja el calor solar al mediodía.
- Controla de manera efectiva la luz, la sombra y la ganancia de calor solar para bloquear el calor en verano y maximizar la luz del día en invierno
- Reduce significativamente el uso de energía del aire acondicionado, la calefacción y la iluminación artificial.
- Reduce los costos relacionados con la energía y las emisiones de gases de efecto invernadero.
- Parámetros de alta acústica 27 dBA
- Ofrece superficies que transmiten luz sobre grandes áreas.

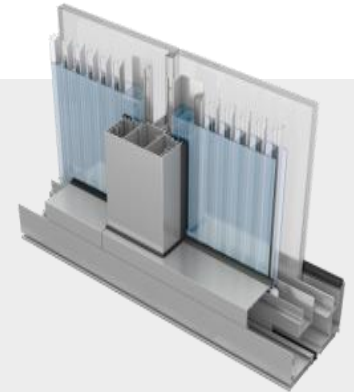

SISTEMA FACHADAS

CONTROLITE
Smart Light Control
Façade System

DANPATHERM
Nueva Generacion
Sistema Fachadas

FAÇADE SYSTEMS

Number of Polycarbonate Companies

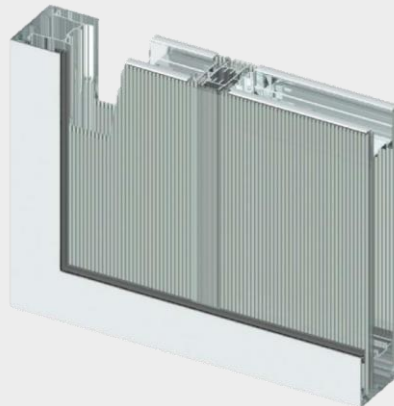

DANPAL DANPATHERM SISTEMA FACHADAS

LA NUEVA GENERACION DE SISTEMAS DE FACHADAS

- El único Sistema de Fachadas de Policarbonato **double glazing** en el mercado
- Los **casetes premontados** únicos de fábrica ahorran tiempo y costos de instalación

Especificaciones: Sistema de fachada de doble acristalamiento; Cassetes premontados

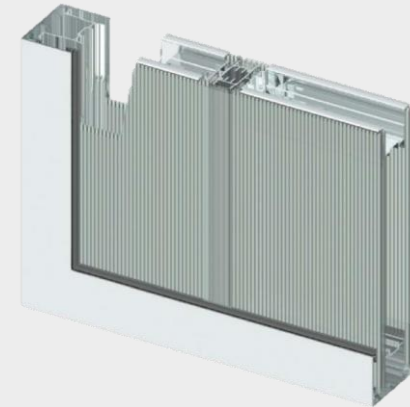

DANPAL DANPATHERM SISTEMA FACHADAS

LA NUEVA GENERACION DE SISTEMAS DE FACHADAS

- El único Sistema de Fachadas de Policarbonato **double glazing** en el mercado
- Los **casetes premontados** únicos de fábrica ahorran tiempo y costos de instalación
- Los paneles dobles permiten **jugar con colores** dentro y fuera del edificio.
- **Reemplazo de la piel**, permite reemplazar el panel donde el edificio sigue estando protegido
- Disponible con/sin Difusor de Luz (**Aislacion**) material
- Disponible con/sin Luz **LED**

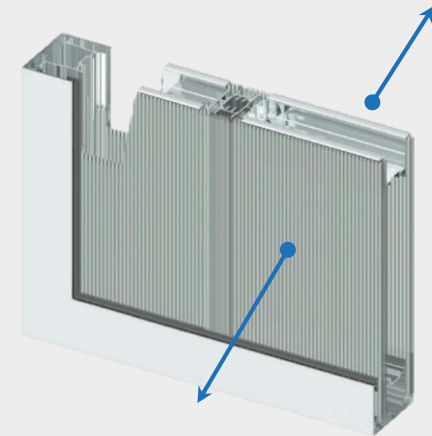

SISTEMA FACHADAS

	CONTROLITE Control Inteligente luz Sistema Fachadas	DANPATHERM Nueva Generacion Sistema Fachadas	SISTEMA FACHADAS
			
Imagen	Best	Better	Good
Competencia	Limited	Less	Regular
Posicionamiento	Smart	New Generation	Regular
Valor U [W/m²K]	0.9	0.52	Adv. Air PT Facade
Max. Span [M]	3.5	6.0	3.5

SISTEMA FACHADAS

	THERMAL ADVANCED AIR PT Sistema Fachadas	ADVANCED NM Sistema Fachadas	TRADITIONAL TP Sistema Fachadas
			
Imagen	Best	Better	Good
Competencia	Limited	Less	Regular
Posicionamiento	Advanced Thermal	Advanced	Regular
Aislacion	Thermal Break	Standard	Standard
Max. Span [M]		3.5	

PROPIEDADES PANELES

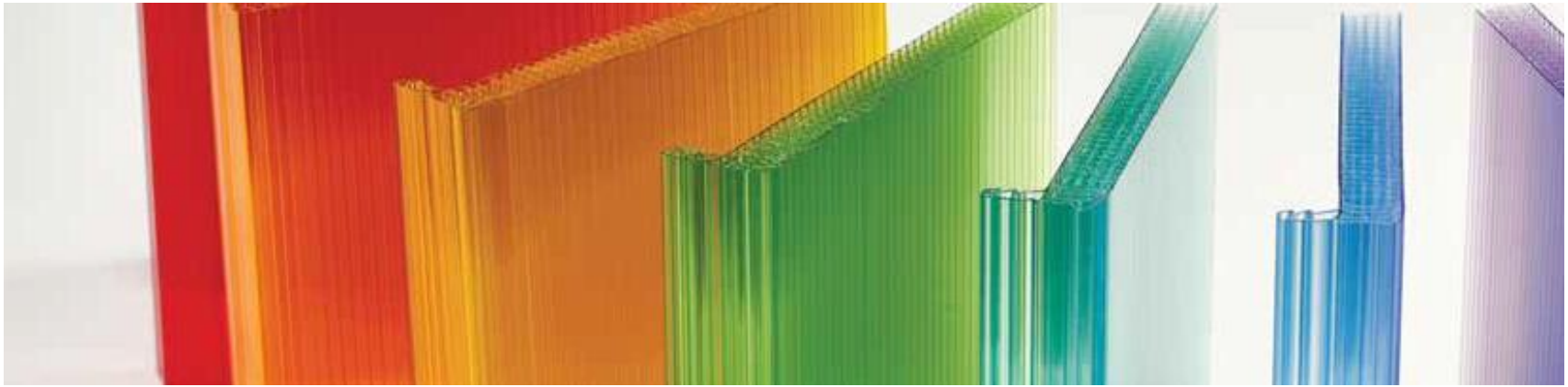

ESTRUCTURA

PANELES UNICOS

COLORES

**TERMINACIONES
UNICAS**

PROPIEDADES PANELES ESTRUCTURA

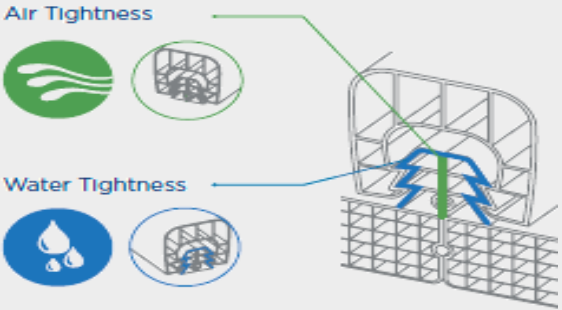
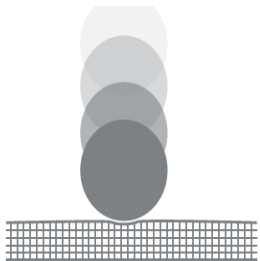
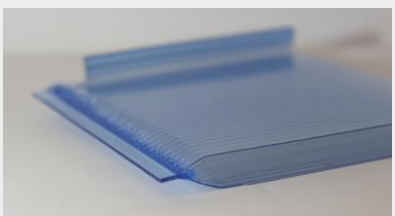
Característica	Figura
Doble Click Sistema Union	<p>Estanqueidad al aire y al agua Y cargas superiores</p> 
Estructura Microcelular	<p>Mecánica mejorada Propiedades, rigidez y resistencia superior al impacto</p> 
Borde Sellado en caliente	<p>Protege al panel del polvo y agua</p> 



PROPIEDADES PANELES PANELES UNICOS

Característica	Figura
Danpalon 3DLITE	<ul style="list-style-type: none">• 600mm panel• 22mm Espesor• Contiene persianas de sombra• Equilibrio de la luz durante todo el dia• Habilita el diseño de arquitectura creativamente, ahorro energia y aumentando la luz energia• Ofreciendo look dinamica

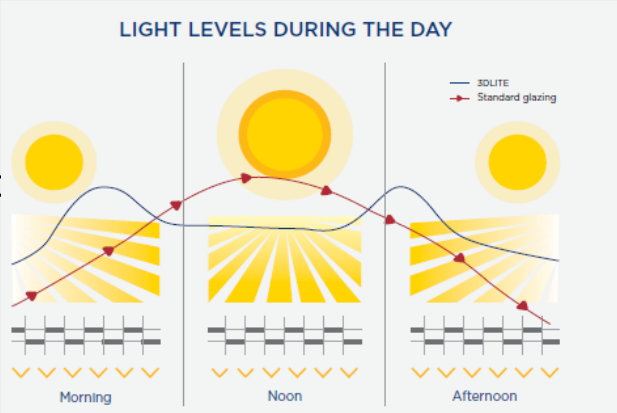

PROPIEDADES PANELES PANELES UNICOS

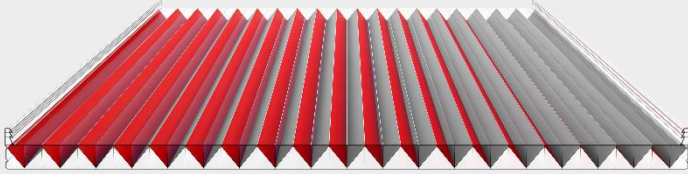
Característica	Figura
<p>Danpalon Kinetic</p>	<ul style="list-style-type: none">• 600mm panel• 16mm espesor• Panel de doble color• Un color en una direccion otro segundo color en otra direccion• Permite a los arquitectos ofrecer diseño innovador• Ofreciendo un luz dinamico 

PROPIEDADES PANELES COLORES

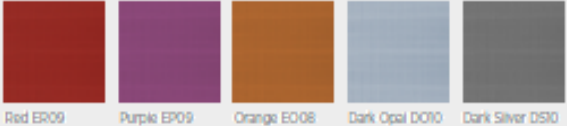
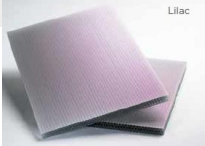
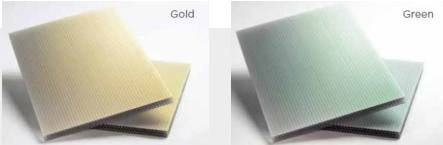
Características	Figura
Codigos Colores Especiales	Danpal tiene terminologia propia  Clear CR57 Ice IC51 Opal OP22
Colores opacos	Menos de 1% LT
Colores de sombreado extra NUEVO	Reduce la luz y radiacion en areas calientes (menos de 10% LT) EXTRA SHADING  Red ER09 Purple EP09 Orange EO08 Dark Opal DO10 Dark Silver DS10
Low E	Permite un mejor uso de la luz dia sin agregar mas calor  Lilac
Iridiscente Apariencia	Alcanzar el color  Gold Green



PROPIEDADES PANELES PANELES TERMINACIONES UNICAS

Características	Figura
Softlite	Asegura el maximo confort visual

HP - High Protection Es un tratamiento superficial avanzado. Permite un mayor rendimiento y proteccion contra daños externos.



SEGMENTOS DE MERCADO



Centros Deportivos



Industria



Educacion



Oficina



Comercial



Transporte

SEGMENTOS DE MERCADO

DANPAL | CONTROLITE FACHADA | CENTRO DEPORTIVO

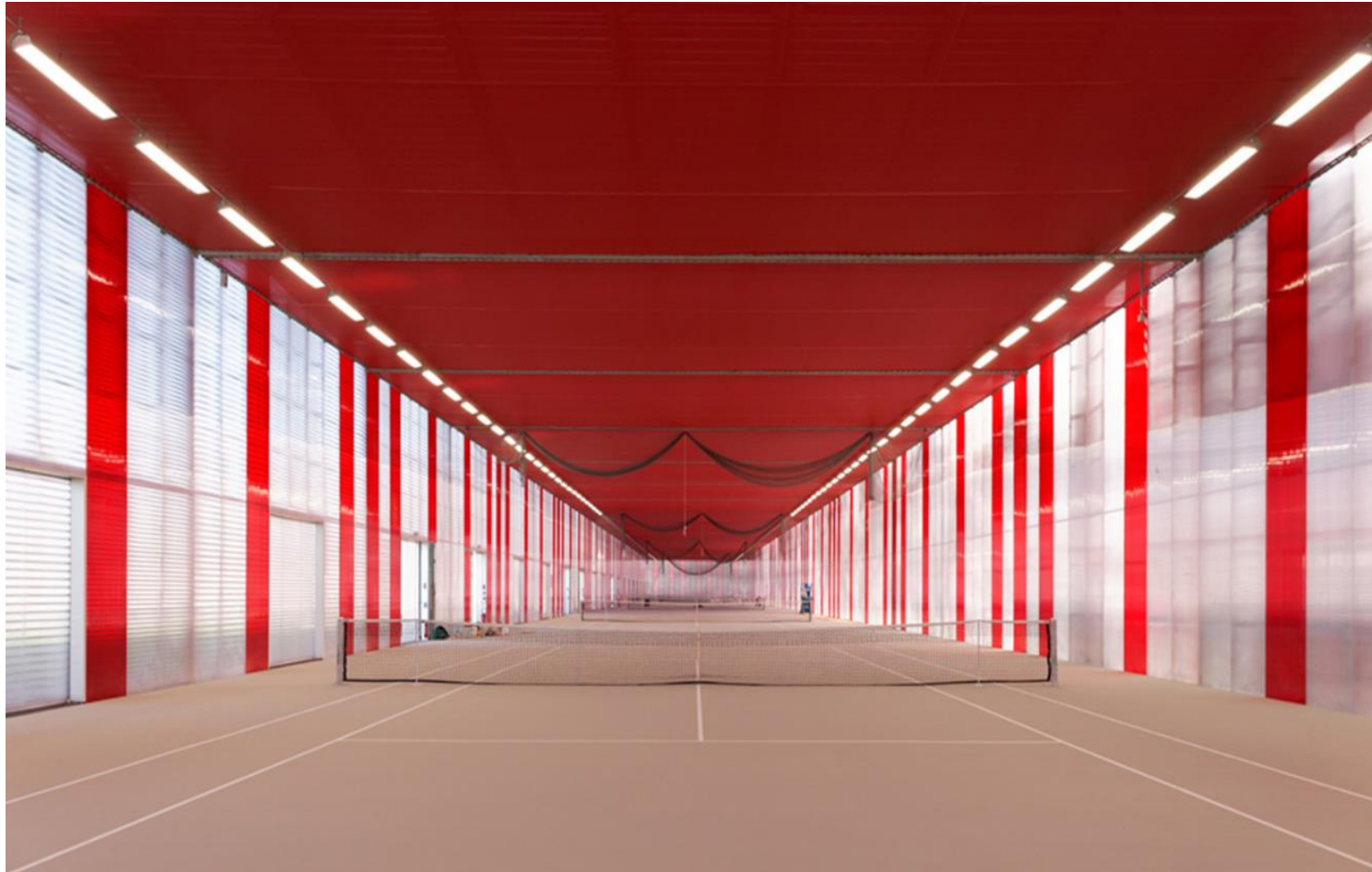

SEGMENTOS DE MERCADO

DANPAL | DANPATHERM SISTEMA



SEGMENTOS DE MERCADO

DANPAL | SISTEMA FACHADAS | INSTITUTO EDUCACIONAL | UK



SEGMENTOS DE MERCADO

DANPAL | SISTEMA FACHADAS



SEGMENTOS DE MERCADO

DANPALON 3DLITE



Thank you